

SKINDICHT® SHV-M FKM

SKINDICHT® SHV-M FKM, robust special sealing cable gland for high temperatures, watertight & resistant to oil, acids and chemicals

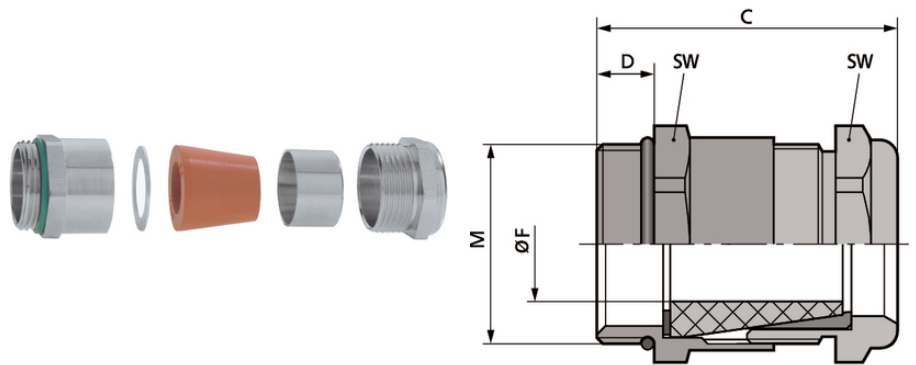

Robust



Temperature-resistant



Waterproof

Benefits

- For high temperatures
- Resistant to oils, solvents, acids and chemicals
- Watertight
- High strain relief
- Robust

Application range

- Watertight and high temperature-resistant cable gland with special conical FKM sealing element
- Brickworks
- Sewage treatment plants
- Car wash sites

Product Make-up

- 1 fitting
- 2 washers
- 3 FKM sealing cone
- 4 brass cones
- 5 compression screws

Note

Last Update (07.05.2024)

©2024 Lapp Group - Technical changes reserved

Product Management www.lappkabel.de

You can find the current technical data in the corresponding data sheet.

PN 0456 / 02_03.16

SKINDICHT® SHV-M FKM

Counter nut to be used: SKINDICHT® SM-M

Example description:

SHV-M-FKM 20/11/7

20 = metric connection thread

11 = PG function thread

7 = clear opening of sealing cone

Technical Data

Classification ETIM 5:	ETIM 5.0 Class-ID: EC000441 ETIM 5.0 Class-Description: Cable screw gland
Classification ETIM 6:	ETIM 6.0 Class-ID: EC000441 ETIM 6.0 Class-Description: Cable screw gland
Caution:	The installation dimensions can be found in appendix T21
Material:	Body: nickel-plated brass Sealing cone: FKM O-ring: FKM
Protection rating:	IP 68 - 10 bar
Temperature range:	-20°C to +200°C

Note

Photographs and graphics are not to scale and do not represent detailed images of the respective products. Prices are net prices without VAT and surcharges. Sale to business customers only.

SKINDICHT® SHV-M FKM

Article number	Article designation / size	Clamping range ØF mm	Function thread PG	SW wrench size mm	Overall length C mm	Thread length D mm	Clear opening F (mm)	Pieces / PU
SKINDICHT® SHV-M FKM								
52105430	M 12 x 1,5	3.8 - 4.8	7	14.0 / 14.0	26.0	5	5.0	50
52105440	M 16 x 1,5	4.8 - 5.8	9	18.0 / 17.0	27.5	5	6.0	50
52105450	M 16 x 1,5	5.8 - 6.8	9	18.0 / 17.0	27.5	5	7.0	50
52105460	M 20 x 1,5	5.8 - 6.8	11	22.0 / 20.0	31.0	6	7.0	25
52105470	M 20 x 1,5	6.8 - 8.8	11	22.0 / 20.0	31.0	6	9.0	25
52105480	M 20 x 1,5	8.5 - 10.8	13.5	22.0 / 22.0	32.5	6	11.0	25
52105490	M 20 x 1,5	6.8 - 8.8	13.5	22.0 / 22.0	32.5	6	9.0	25
52105500	M 20 x 1,5	10.8 - 12.8	16	24.0 / 24.0	34.5	6	13.0	25
52105510	M 20 x 1,5	13.8 - 14.8	16	24.0 / 24.0	34.5	6	15.0	25
52105520	M 25 x 1,5	15.8 - 17.8	21	30.0 / 30.0	38.0	7	18.0	25
52105530	M 25 x 1,5	17.5 - 19.8	21	30.0 / 30.0	38.0	7	20.0	25
52105540	M 32 x 1,5	19.5 - 21.8	29	40.0 / 40.0	44.5	8	22.0	10

Last Update (07.05.2024)

©2024 Lapp Group - Technical changes reserved

 Product Management www.lappkabel.de

 You can find the current technical data in the corresponding data sheet.
 PN 0456 / 02_03_16